

# Framework Of Information System Of IT Service Desk Using UML (Unified Modelling Language) Technique - Study Case In Republic Of Indonesia State Civil Service Agency

*by Melyani Melyani*

---

**Submission date:** 14-May-2024 10:09AM (UTC+0700)

**Submission ID:** 2378839504

**File name:** JTIE\_2024.docx (686.99K)

**Word count:** 3871

**Character count:** 20804



## Framework Of Information System Of IT Service Desk Using UML (Unified Modelling Language) Technique - Study Case In Republic Of Indonesia State Civil Service Agency

Melyani<sup>1</sup>, Ahmad Rafik<sup>2</sup>, Roydawaty<sup>3</sup>, Indra Riyana<sup>4</sup>, Rizkiana Karmelia Shaura<sup>5</sup>,  
Hendra Kurniawan<sup>6</sup>, Rahayu Swastika<sup>7</sup>

<sup>1,2,3,4,5,6,7</sup>Universitas Bina Sarana Informatika

E-mail: [melyani.myn@bsi.ac.id](mailto:melyani.myn@bsi.ac.id)<sup>1</sup>, [ahmad.aaf@bsi.ac.id](mailto:ahmad.aaf@bsi.ac.id)<sup>2</sup>, [roydawaty.obs@bsi.ac.id](mailto:roydawaty.obs@bsi.ac.id)<sup>3</sup>,  
[riyana.irr@bsi.ac.id](mailto:riyana.irr@bsi.ac.id)<sup>4</sup>, [rizkiana.rkl@bsi.ac.id](mailto:rizkiana.rkl@bsi.ac.id)<sup>5</sup>, [hendra.hku@bsi.ac.id](mailto:hendra.hku@bsi.ac.id), [rahayu.ryw@bsi.ac.id](mailto:rahayu.ryw@bsi.ac.id)

Email Correspondence : [melyani.myn@bsi.ac.id](mailto:melyani.myn@bsi.ac.id)

### Article History:

Received: 01 April 2024

Accepted: 13 Mei 2024

Published: 31 Agustus 2024

**Keywords:** *IT Service Desk  
Information System, MySql, ,  
Unified Modeling Language  
(UML)*

### Abstract

At Republic of Indonesia State Civil Service Agency in carrying out work, it is often found that problems both software and hardware are installed in the computer and must be resolved immediately. However, the handling of problems is still not good, where in the process of reporting complaints and requests, you still have to go by telephone or come directly to the IT staff office to notify complaints, as well as in manual records that affect company performance. All recording reports and problem calculations are still manual. This can have a negative effect, namely: there are problems that are at risk of being recorded repeatedly, so it takes a long time to provide reports to managers. Therefore, the authors submit a helpdesk information system application to solve the problems of complaints and employee requests so that they can be resolved quickly and can be handled properly as well as recording reports that are well recorded. In developing this helpdesk information system, the author uses an object-oriented methodology, namely the iteration waterfall, which is modeled using UML (Unified Modeling Language). The tools used are XAMPP as a web server, PHP as a programming language and MySQL as a database. With this system, it is hoped that it can make it easier for employees to report complaints as well as get solutions to the problems they are complaining about and also make it easier for IT staff to automatically generate reports in the system.

## A. INTRODUCTION

The rapid development of technology in the world has brought the world to a very sophisticated state. As well as the discovery of computers as data processing tools and also the internet which has become the main weapon in competence. And as time goes by, the role of information technology has had a very positive impact in improving the quality of human life. There are many things that can be done with technology, for example the Helpdesk Information System which is expected to be able to overcome all problems that exist in the company, both internal problems and application operations or those related to information systems and technology.

Currently the IT Service Desk Information System at the State Civil Service Agency

of the Republic of Indonesia is only used by telephone, Android application, namely What Sapp or coming directly to the IT Staff office to report employee complaints. And there are also employee/user complaints about whether the problem has been resolved or not and there are no records of these complaints that can be reported to superiors.

Based on these problems, it is necessary to create an IT Service Desk information system that can be easily used to serve employees. This IT Service Desk information system will help users create problem forms that can be sent directly to IT staff, help IT staff control all employee work on problems related to computer equipment, can help compile staff work reports IT, and also helps management make decisions by looking at problems related to information technology.

## **B. LITERATURE REVIEW**

### **Information System**

An information system is part of a set of interconnected components that can collect, process, store and distribute information to support decision making. Apart from that, information systems can also help in analyzing problems, visualizing complex subjects and creating new products, as stated by (Rizki, 2015: 10).

### **IT Service Desk**

According to (Rikip, 2016). The IT Service Desk is a resource intended to provide information and support to users related to products and services within the company. The purpose of the IT Service Desk is to solve or resolve problems regarding products such as computers, electronic equipment, etc. Usually companies design an IT Service Desk to provide assistance to employees

### **IT Service Desk Function**

According to (Gunawan, 2018) the functions of the IT Service Desk are:

1. As the complexity of problems that are integrated with the system.
2. Has varied functionality.
3. Reporting is key to the application as reports for third parties can be specified by the user.
4. The level of management service is important as a measure of the success of the IT Service Desk application.



## Unified Modeling Language

Some of the UML diagrams used in designing this helpdesk information system are: usecase diagrams, activity diagrams, class diagrams, sequence diagrams, state diagrams, and deployment diagrams.

### Usecase Diagram

Usecase Diagram is a type of diagram in UML that describes interactions between systems and actors. Use case diagrams can also describe the type of interaction between the system user and the system, as stated by (Qoyyimah, 2011).

**Tabel 1** Usecase Diagram Table

Symbol	Name of Symbol	Information
	Actor	Everything that represents the role of people interacting with the system to exchange information
	Usecase	Abstraction and interaction between systems and actors
	Association	The link between actors and use cases
<<extend>>	Extends	Relationships between use cases that occur as a result of expanding the function of one use case.
	Include	Relationships between use cases that do not repeat use cases



Sources: Qoyyimah:2011

### **Class Diagrams**

Class diagrams are a type of UML diagram that is used to display classes of objects that have the same attributes and behavior. Showing the object classes that make up a system and also the relationships between these object classes was conveyed by (Rizki, 2015).

### **State Diagrams**

A state diagram is a type of UML diagram that describes transitions or changes in the state of an object which causes the object to switch from one state to another, as stated by (Qoyyimah, 2011).

### **Deployment Diagram**

A deployment diagram is a UML diagram that shows the physical layout of a system, or also displays the software parts contained in the hardware, as stated by (Qoyyimah, 2011).

### **Database (DataBase)**

According to (Qoyyimah, 2011) A database is a collection of linked data from an enterprise or related to each other which can be stored on computer hardware and requires software to manipulate the database or in essence is a medium for storing data. so that it can be accessed easily and quickly).

According to (Qoyyimah, 2011), several advantages of databases on file processing systems are:

1. Excessive data can be reduced.
2. Easy to use data.
3. Easy to carry out data security.
4. Make it easy for users to share data at any time. Some of the weaknesses of databases are as follows:

1. The storage used is large.
2. Skilled personnel are needed in managing data.
3. The software is expensive.
4. Damage to the database system can affect related departments.
5. Deadlock occurs.

Some of the database objectives are as follows:

1. Efficiency includes speed, space and accuracy.
2. Can handle large amounts of data.
3. User togetherness.
4. Eliminate duplication and inconsistent data.

### **Waterfall Method**

According to (Candra, 2011). The linear sequential or waterfall method proposes an approach to systematic and sequential software development that starts at the system level and progresses throughout analysis, design, code, testing and maintenance.

The following are the stages of the waterfall method.

#### a. Requirements analysis and definition

Services, limitations, and system objectives are determined in consultation with system users. These requirements are then defined in detail and serve as system specifications.

#### b. System and software design

The system design process divides the requirements into a hardware or software system. This activity determines the overall system architecture. Software involves the identification and description of fundamental software system abstractions and their relationships.

#### c. Implementation and unit testing

Software design is realized as a series of programs or program units.

#### d. System integration and testing

Program units are integrated and tested as a complete system to ensure that system requirements are met. System testing is carried out using the black box method. After system testing, the software is shipped to the customer.

#### e. Operation and maintenance (maintenance)

The system is installed and used. Maintenance includes various errors that were not discovered in previous stages.

### **Entity Relationship Diagram (ERD)**

ERD is a way of modeling data using several notations to describe data related to entities and described by that data. The basic concept of the ERD data model consists of entities, attributes, relationships and lines, as stated by (Jacky, 2014).

To help provide a complete picture of relationships, there are also 3 types of relationships in

attribute relationships in one file according to (Candra, 2011), namely:

**1. One to one relationship**

The relationship between the first and second files is 1 to 1, which is depicted with a circle to indicate the table and the relationship is depicted with a single arrow.



**2. One to many relationships**

The relationship between the first and second files is 1 to many or vice versa. The relationship can be depicted with multiple arrows to show the relationship.

**3. Many to many relationships**

The relationship between the first and second files is many to many.

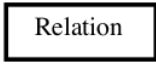
**Table 2 ERD Symbol (Entity Relationship Diagram)**

Notasi	Information
	An entity is an object that can be identified in the user environment
	Relationship is the part that shows the relationship between a number of entities
	The function attribute describes the character of the entity
	Lines are a connection between relationships and entities or relationships and entities with attributes

**Black Box Testing**

Black Box Testing is software quality testing that focuses on the functional requirements of the software. A test so to speak is successful if a system can process data according to what is expected. Black box testing aims to find incorrect functions, interface errors, errors in data structures, initialization and termination performance errors (Lila, 2019).

**C. RESULT AND DISCUSSION**

At this stage, several stages are carried out, namely analyzing and understanding the problems or systems currently running in the agency, and making proposals for new or

proposed systems.

### System Design Flow Service Desk

The Service Desk of the State Civil Service Agency of RI has the task of providing information and handling disturbances if there are problems with internet use. And the system that runs in the Indonesian state civil service agency:

- a. Any information or problems will be conveyed to the helpdesk at the Indonesian state civil service agency in 3 ways, namely: Via telephone, via Whatsapp, or by coming directly to the IT staff office.
- b. The absence of computerized reports is one of the factors for the Head of IT to evaluate the results of reports on existing problems.

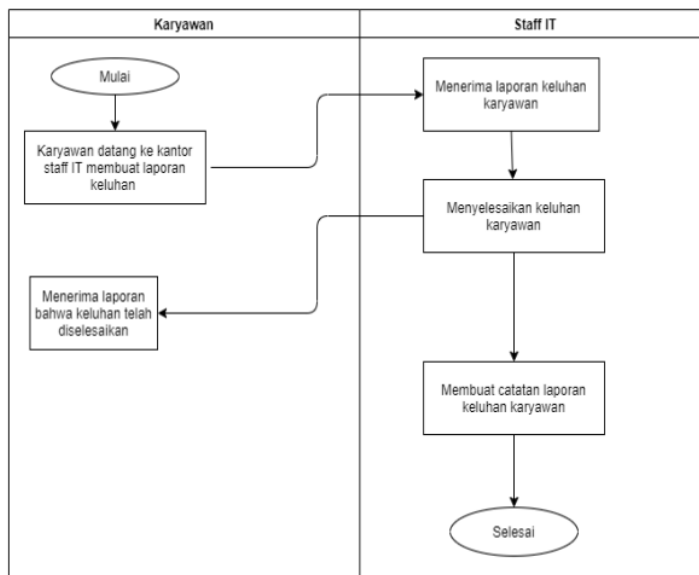

Figure 1. Existing System Design Flow of Service Desk

### Systems Design Analysis

From the results of the analysis of existing problems, a system is needed that is able to resolve and monitor problems that occur so that in real time problems can be handled properly. A well-integrated database to create a problem solution that can provide accurate reports.

User needs are identified, namely: a well-integrated database, systemized problem recording, accurate monthly reports, information on problems that occur, and clear handling of problems by who handles them.

Therefore, the author provides a solution as a solution to the problem of user needs, namely:



**FRAMEWORK OF INFORMATION SYSTEM OF IT SERVICE DESK USING UML (UNIFIED MODELLING LANGUAGE) TECHNIQUE - STUDY CASE IN REPUBLIC OF INDONESIA STATE CIVIL SERVICE AGENCY**

- a. A system that has access rights to certain parties to be able to obtain information about problems handled by the helpdesk, designing a system in real time for recording problems.
- b. A system with accurate report results to assist the Head of IT in evaluating report results and can measure the level of problems at the helpdesk in handling existing problems both related to internet network connections and hardware damage.

**Proposed Framework of Service Desk**

The system that will be developed has a function that can help the helpdesk to receive reports of problems that arise and immediately input data on the problem or go to the reporter to handle the problem.

Problem reports handled by the helpdesk section can be done online using the internet if there is hardware and software damage to the client and if it cannot be resolved online then it will be resolved directly and then recording and calculating the problem will be used as a report to the Head of IT to determine further policies.

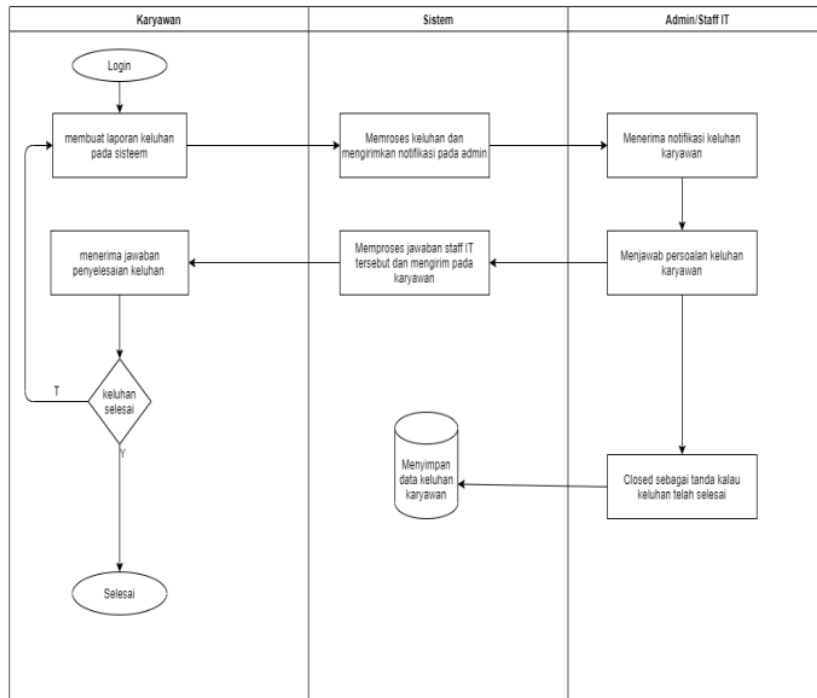

**Figure 2 . Framework of Information System for Service Desk**

**System Design of System Information**

At this stage, the system design is carried out based on the results of the analysis that has been carried out.

### Designing Usecase Diagrams

Use cases are designed to describe actor activities in the system. Following is the identification of use case requirements

**Table 3 Identify User Need**

No	UseCase Name	Description	Actor
1	Create A New Ticket	Create New Ticket	User
2	Create Assign Ticket	Create Ticket Assignment on Service desk system	Admin, Staff IT
3	Create Respons Ticket	Create an answer ticket in the system Service desk	Admin, Staff IT
4	Create A New User	Create a new user on the system Service desk	Admin
5	Edit Ticket	Editing Tickets that have status open	User
6	Change Status Ticket	Change the status of an owned Ticket progress status becomes closed	Admin, Staff IT
7	Create Report Ticket	Create a closed ticket report	Admin, Staff IT
8	View All Ticket	View tickets created by users who log in to the servicedesk system	Admin, Staff IT, User

9	Search Ticket	Search for tickets based on open, progress, closed status categories	Admin, Staff IT, User
10	Edit User	Changing user information in the system servicedesk	Admin
11	Delete User	Delete existing users on the system	Admin
12	View User	View the list of existing users servicedesk system	Admin
13	Search User	Search for users in the servicedesk system	Admin

**Use Case Diagram IT Staff**

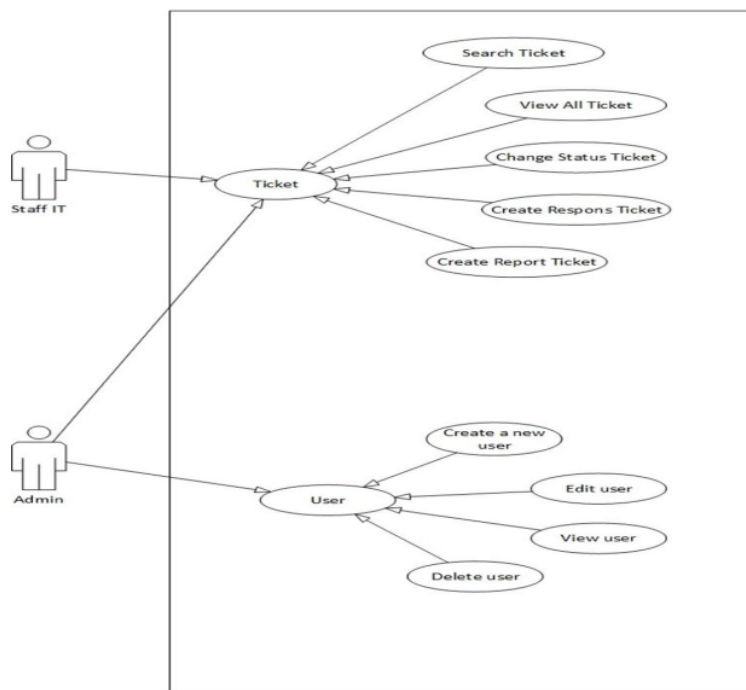

**Figure 3 Use Case Diagram IT Staff**

### Usecase Diagram User/Employee

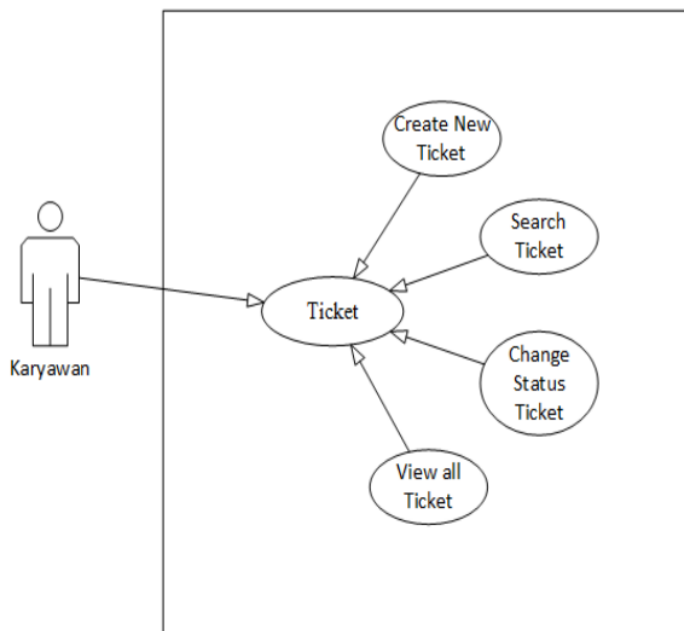
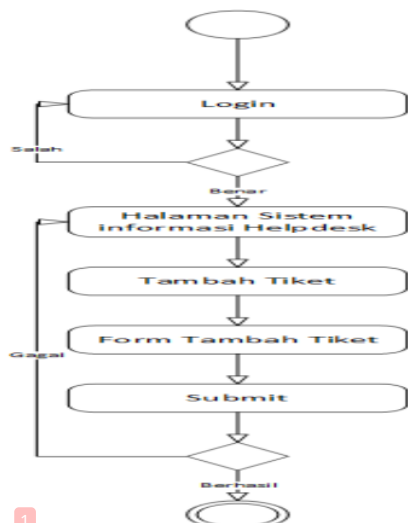

Figure 4 Use Case Diagram User / Employee

### Designing Activity Diagrams

Activity Diagrams are used to describe the activities carried out by actors in the helpdesk system.



**Figure 5 Activity Diagram Create New Ticket**

The create new ticket activity diagram depicts the actor's activities in creating a new ticket in the helpdesk system. To carry out the process of creating a new ticket, the actor must first log in to the helpdesk system, then select the new ticket function, then the system will display the new ticket form. After that, the actor fills in the information on the new ticket he will create and then selects submit so that the data is stored in the helpdesk information system.

### Activity Diagram Create Respons Ticket

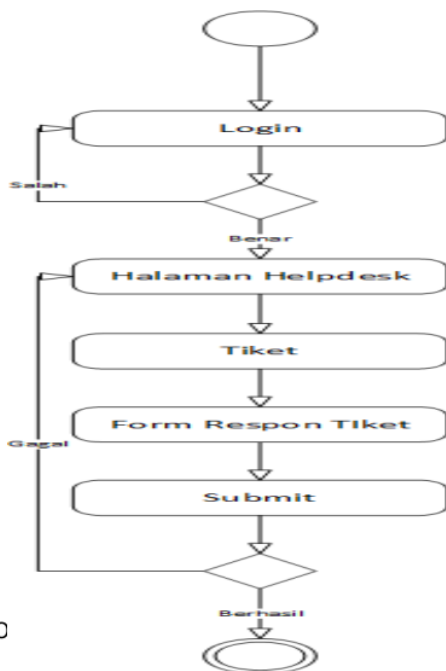

**Figure 6 Activity Diagram Create Response Ticket**

This activity diagram explains the ticket response activity process. Activities carried out by IT staff. In order to be able to respond to a ticket, an actor must first log in to the service desk system then go to the ticket page that will be responded to, after selecting a response the actor will fill in the information related to the ticket then select submit.

1  
**Activity Diagram Create Change Status Ticket**

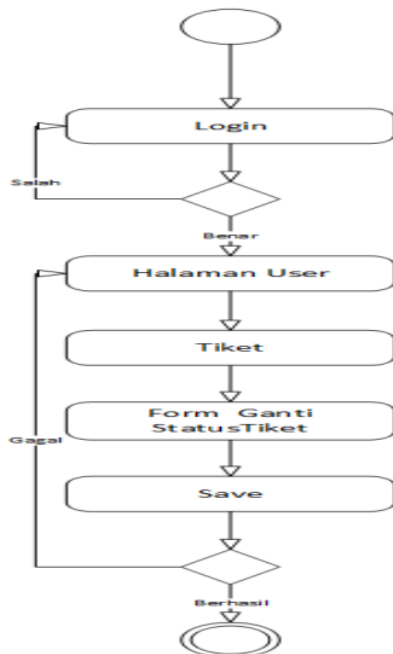

**Figure.7 Activity Diagram Create Change Status Ticket**

In this activity diagram, it explains the activity process of changing the ticket status by the actor. The actors involved are IT staff and admin. To carry out this activity, an actor must first log in to the helpdesk system, then open the ticket that will be worked on and then he can carry out the activity of changing the ticket status. In changing the ticket status if the ticket is being worked on, the actor will change the ticket status to progress, and will change it again to closed if the ticket has been completed.

### 1 Activity Diagram Edit Ticket

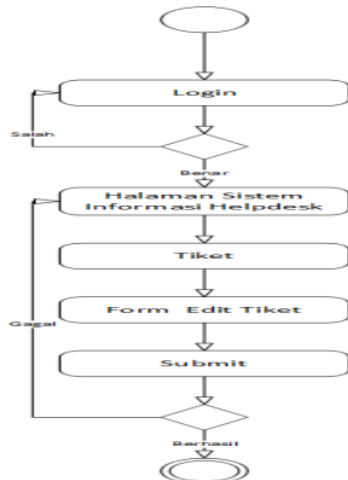

Figure.8 Activity Diagram Create Edit Ticket

In the activity diagram, this diagram explains the activity of changing ticket information by the actor. The actor involved is the user. To change or edit a ticket, the actor must first log in to the system and then choose which ticket to change, but the tickets that can be changed are only tickets that still have open status, otherwise they cannot be changed again by the user.

### 1 Activity Diagram Create Report Ticket

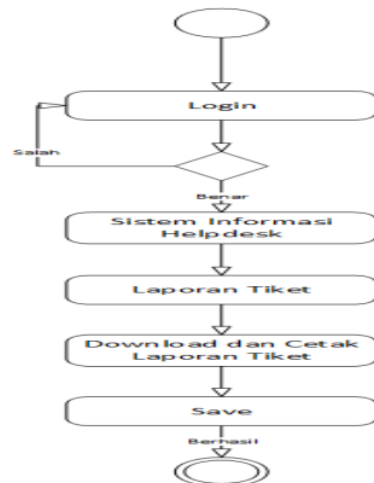

Figure 9 Activity Diagram Create Report Ticket

This diagram explains the activity process of making a ticket report, the actors involved are admin and IT staff. To create a ticket report, a ticket must have fixed status. When printing a



report, you can select whether you want to create a report based on the date and also based on which category of report you want to print, then select show to display the ticket that will be reported, after that the report can be created in Excel format and then printed to be used as a report.

### Sequence Diagram

Sequence Diagrams are a series of messages that describe interactions between objects in a helpdesk information system. The following is a sequence diagram for the system to be built.

#### Sequence Diagram Login User

The User Login Sequence Diagram explains the flow a user takes to log in to the system

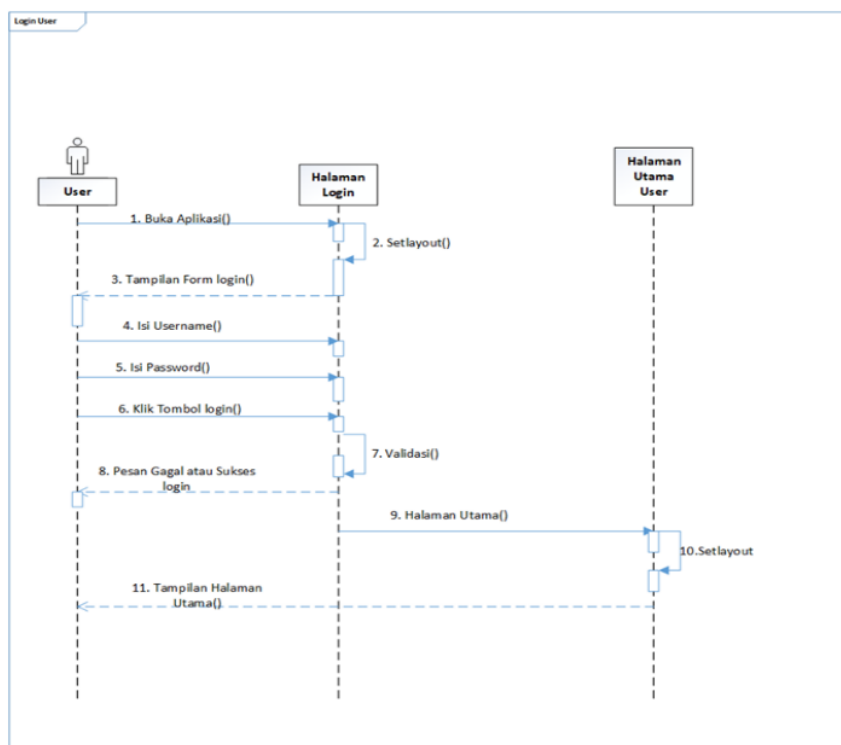

**Figure 10 Sequence Diagram Login User**

#### 1 Sequence Diagram Create New Ticket

The Create New Ticket Sequence Diagram explains the flow of how a user creates or adds a ticket to the service desk information system.

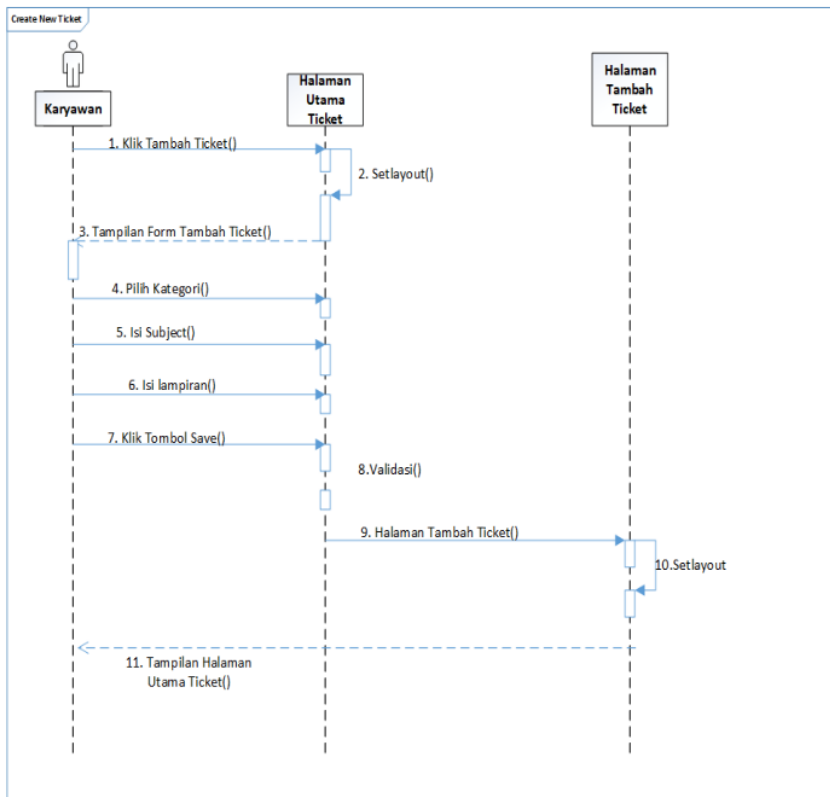

1  
**Figure 11 Sequence Diagram Create New Ticket**

### **Sequence Diagram Create Respons Ticket**

The Response Ticket Sequence Diagram explains the flow of how to respond to tickets that have been created by users/employees

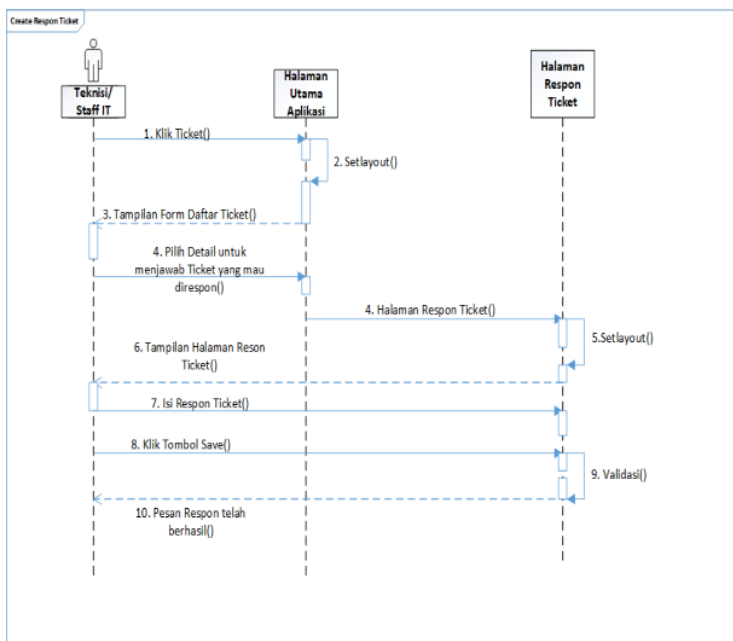

**Figure 12** Sequence Diagram Create Response Ticket

**Sequence Diagram Create Change Status Ticket**

The Change Status Ticket Sequence Diagram explains the flow of how a ticket that has been created by a user will change its status, starting from open, where the ticket has been received, progress, which is when the ticket will be worked on, and closed when the ticket has been completed.

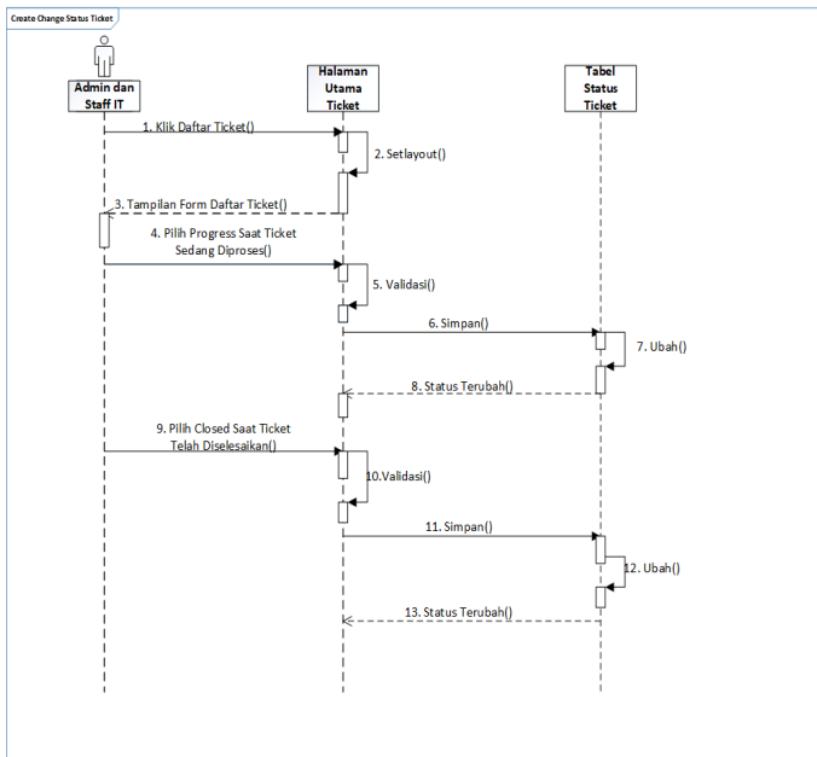
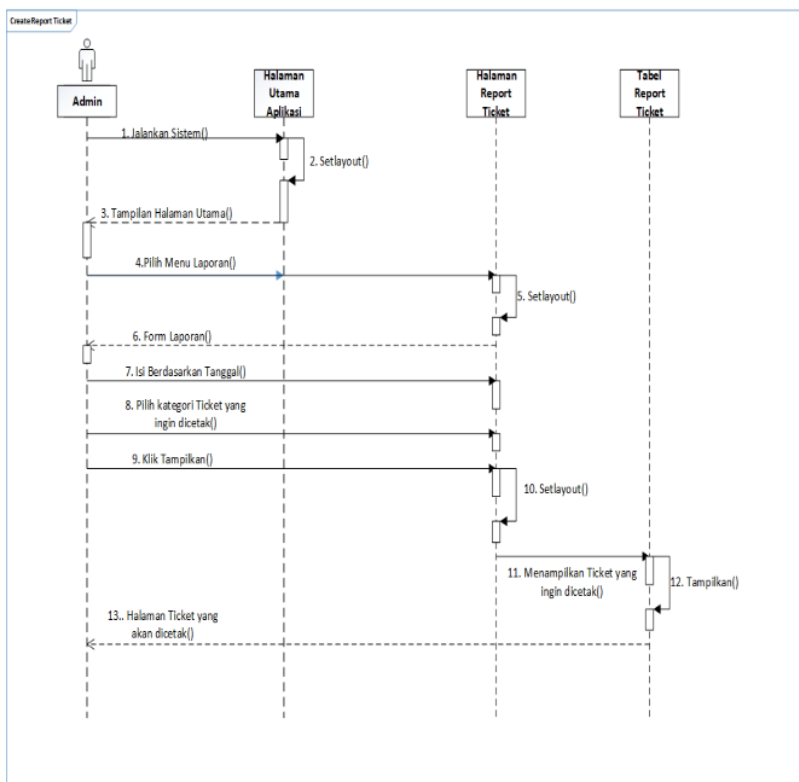

Figure.13 Sequence Diagram Create Change Status Ticket

### Sequence Diagram Create Report Ticket

The Create Report Ticket Sequence Diagram explains the process of how an actor, namely the admin, creates and prints ticket/complaint reports from employees.

**FRAMEWORK OF INFORMATION SYSTEM OF IT SERVICE DESK USING UML (UNIFIED MODELLING LANGUAGE) TECHNIQUE - STUDY CASE IN REPUBLIC OF INDONESIA STATE CIVIL SERVICE AGENCY**



**Figure 14 Sequence Diagram Create Report Ticket**

### Database Design

A database is a collection of data that forms a file that is interconnected (relationship) with a certain procedure to form new data or information.

### ERD (Entity Relationship Diagram)

ERD is a diagram that shows the relationships between entities in the system.

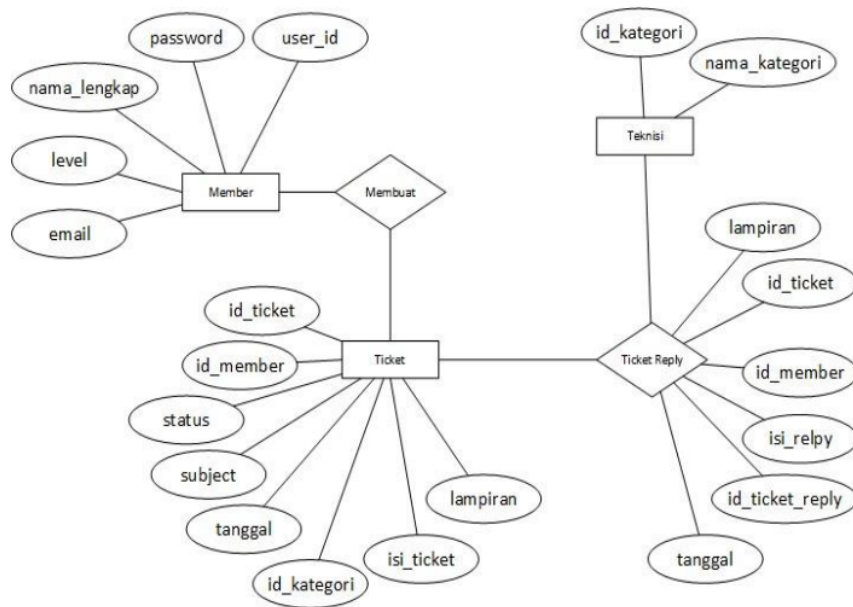

**Figure 15 ERD (Entity Relationship Diagram)**

**Table Specifications**

The table specifications in designing the IT helpdesk information system program consist of one database name, namely helpdesk and the following is a description of the table specifications used.

A. Table of Category

Table 1 of Category

Name	Type	Length
Id_kategori	varchar	3
nama_kategori	varchar	20
Blokir	Enum	'Y', 'N'

B. Table User

Table 2 User

**FRAMEWORK OF INFORMATION SYSTEM OF IT SERVICE DESK USING UML (UNIFIED MODELLING LANGUAGE) TECHNIQUE - STUDY CASE IN REPUBLIC OF INDONESIA STATE CIVIL SERVICE AGENCY**

<b>Nama Field</b>	<b>Data of Type</b>	<b>Length</b>
User_id	Int	5
Password	varchar	50
Nama_lengkap	varchar	100
Email	Varchar	100
Blokir	Enum	'Y', 'N'
Foto	varchar	100
Status	enum	'Y', 'N'
Level	varchar	20
Tanggal	varchar	10

**C. Table Ticket**

Table 3 Ticket

<b>Nama Field</b>	<b>Data Type</b>	<b>Length</b>
id_tiket	varchar	3
id_kategori	varchar	3
id_member	varchar	100
Subject	varchar	100
Isi_tiket	text	
Lampiran	varchar	50
Status	enum	'Open', 'Closed', 'Progress'
Tanggal	varchar	10
Jam	varchar	10
Baca	enum	'B', 'S'
Point	enum	1
Bulan	varchar	15

**D. Ticket Reply**

Table 4 Ticket Reply

Nama Field	Data Type	Length
Id_tiket_reply	varchar	3
Id_tiket	varchar	3
Id_member	varchar	50
Isi_reply	Text	
Tanggal	varchar	10
Jam	text	
Lampiran	varchar	50

#### D. CONCLUSION AND IMPLICATION

##### CONCLUSION

Based on the discussion carried out on the Helpdesk Information System, several conclusions were obtained: Handling complaints and damage to software and hardware at PT. PLN (Persero) UPP Labuhan Angin, North Sumatra has become more controlled. Problem recording can be done systematically, so that the data is safe and accurate and there is no duplication. IT Division/Staff can provide solutions to questions regarding computer problems without having to meet employees directly.

##### IMPLICATION

Based on the results of the research and discussion and conclusions that have been put forward, the following are several suggestions that are expected to become input and material for consideration: After the system has been successfully implemented, it will be further developed by adding new features. The scope of problem handling can be expanded, so that the Head of IT can get a broad picture of the problems occurring in the company. The company pays attention to the technology used in the company so that it can help employees in doing their work. It is necessary to provide outreach to employees regarding the use of this helpdesk information system so that employees can easily understand it use a new system so that there are no errors in entering data or using it.

The Service desk Information System created for logging in can only use the username and password that have been registered with the previous admin and cannot be changed according



to the wishes of the user or employee, so it is hoped that in the future there will be developments where users can register themselves and change their username or password. password according to their wishes so that there are no errors regarding users forgetting their username and password.

## REFERENCES

- Andre. 2019. Understanding and Functions of PHP in Web Programming. Available at <https://www.duniaikom.com/pengertian-dan-function-php-dalam-pemograman-web/> (accessed 28 April 2020).
- Apriyanto, Candra N. 2011. Web-Based Watch Sales Information System at CV. Bright Rays of Semarang. Thesis. Yogyakarta. Yogyakarta Veterans National Development University
- Bailintin. 2017. Understanding UML and its types and examples of diagrams. available at <http://bailintin.blogger.mercubuana.ac.id/2017/09/15/pengertian-uml-dan-jen-jennya-Sert-cepat-diagramnya/> (accessed 28 April 2020)
- Ginjar, Rikip., Kresnotutuko, M. Kahfi., Wahyu, R.B., Hasrito, Eko Syamsudin., Wahyu, Yuyu., Sulisty, Budi. 2016. Helpdesk Information System. SEMNASTIKOM. President University.
- Harminingtyas, Rudika. 2014. Analysis of website services as promotional media, transaction media and information media and their influence on the company's brand image at the Ciputra Hotel in Semarang City. STIE Semarang. Vol.6, no.3
- Hermawan. 2019. Understanding XAMPP along with functions and important parts of XAMPP. Available at <https://www.nesabamedia.com/pengertian-xampp/> (accessed 28 April 2020).
- Kristin, Eunice. 2014. Web-Based Personnel Information System to Support Leadership Decisions at Stekom Semarang. STEKOM Semarang Student Journal, vol.1, no.1
- Laudon, Kenneth C, Laudon, Jane P. 2012. Management Information Systems: Managing the Digital Company. Jakarta. Salemba Four.
- Mudhar, Rizki. 2015. Development of a helpdesk ticketing information system using the Django framework. Thesis. Jakarta: Syarif Hidayatullah State Islamic University.
- Po, jacky, Dwi Putranto, Julianto, Born, Errys, Gintoro. 2014. Helpdesk Information System for Complaints and Requests for Web-Based Software and Hardware. Thesis. Jakarta: Bina Nusantara University.
- Qoyyimah. 2011. Design and Development of a Helpdesk Ticketing System (Case Study: PT. Primus Indojoya). Jakarta. UIN Syarif Hidayatullah Jakarta.
- Saputra Mirza, Dhani. 2011. Development of the Personnel Information System "SIMPEG". Jakarta
- Setiyani, Lila. 2019. Testing the Inventory Information System in Pharmaceutical Distributor Companies Using the Black Box testing method. Journal of Computer Science and Information Technology, Vol.4, No.1.
- Simanjuntuk, ELvin. 2013. Website-Based Marketing Information System at PT. Trimitra as a means of selling products online. Thesis. East Java. East Java Veterans National

Development University.

Ulti Desi Arni. 2018. Understanding UML and UML Components. Available at [garudacyber.co.id/article/1471-pengertian-uml-dan-kompon-uml](http://garudacyber.co.id/article/1471-pengertian-uml-dan-kompon-uml) (accessed 28 April 2020)

# Framework Of Information System Of IT Service Desk Using UML (Unified Modelling Language) Technique - Study Case In Republic Of Indonesia State Civil Service Agency

## ORIGINALITY REPORT

20%

SIMILARITY INDEX

20%

INTERNET SOURCES

4%

PUBLICATIONS

3%

STUDENT PAPERS

## PRIMARY SOURCES

1	<a href="https://repository.uma.ac.id">repository.uma.ac.id</a> Internet Source	12%
2	<a href="https://jtie.stekom.ac.id">jtie.stekom.ac.id</a> Internet Source	3%
3	<a href="https://journal.yrpipku.com">journal.yrpipku.com</a> Internet Source	2%
4	Oktaviano Nanda Prima Setya, Widodo, Murien Nugraheni. "Moodle-based Learning Management System Design as a Learning Media at SMKN 40 Jakarta", 2023 7th International Conference on New Media Studies (CONMEDIA), 2023 Publication	1%
5	Submitted to Taylor's Education Group Student Paper	1%
6	Yusmartato, Indra Gunawan, Murni Sari Rahayu, Dedi Kusbiantoro et al. "Grouping 2 Hour Load Data Substation Using Hierarchical	1%

# Clustering", Journal of Physics: Conference Series, 2019

Publication

7

[garuda.kemdikbud.go.id](http://garuda.kemdikbud.go.id)

Internet Source

1 %

8

[proceeding.dharmawangsa.ac.id](http://proceeding.dharmawangsa.ac.id)

Internet Source

1 %

Exclude quotes  On

Exclude matches  < 1%

Exclude bibliography  Off

# Framework Of Information System Of IT Service Desk Using UML (Unified Modelling Language) Technique - Study Case In Republic Of Indonesia State Civil Service Agency

GRADEMARK REPORT

FINAL GRADE

GENERAL COMMENTS

**/0**

PAGE 1

PAGE 2

PAGE 3

PAGE 4

PAGE 5

PAGE 6

PAGE 7

PAGE 8

PAGE 9

PAGE 10

PAGE 11

PAGE 12

PAGE 13

PAGE 14

PAGE 15

PAGE 16

PAGE 17

PAGE 18

PAGE 19

PAGE 20

---

PAGE 21

---

PAGE 22

---

PAGE 23

---

PAGE 24

---

PAGE 25

---